



PLASTIX FANTASTIX INC.

For all your plastics needs...

PRODUCT CATALOG



PLASTIX FANTASTIX INC.

For all your plastics needs...

TABLE OF CONTENTS

About Us 4
 Materials 4
DISPLAY RISERS 5
 Round Display Risers – 3 Tier..... 5
 Round Display Risers – 4 Tier Square Base..... 5
 Round Display Risers – 4 Tier Curved Base 5
 Round Display Risers – 5 Tier..... 6
 Tube Display 6
 Step Riser – 3 Tier 6
 Step Riser – 4 Tier 7
 Cube Riser/Cover..... 7
 Rectangular Risers 7
JEWELLERY DISPLAYS 8
 Jewellery Card Slatwall Display 8
 Triangular Slatwall Mount Jewellery Display 8
 Jewellery Card Display – Free standing 8
 Bracelet Display – Single Arm 9
 Bracelet Display – Two Arm 9
 Eyeglass Display..... 9
BUSINESS CARD & BROCHURE HOLDERS 10
 Business Card Holders - Single 10
 Business Card Holder – Multiple – Screw /Slat Wall Mount..... 10
 Business Card and Brochure Holder..... 11
 Business Card Holder – Multiple - Freestanding..... 11
 Brochure Holder - Single 11
 Brochure Holder – Free Standing 12
 Brochure Holder – Multiple – Wall Mount 12
 Brochure Holder – Multiple Tier 12
 Counter Pocket..... 13
 Magazine Holder – Wall mount..... 13
BULK BINS..... 14
 Bulk Food Bin..... 14
 Bulk Food Bin – Optional Scoop Holders 14
DRAW & DONATION BOXES 15
 Draw Box 15
 Donation Box 15
GREETING CARD HOLDERS 16
 Greeting Card Rack - Single 16



PLASTIX FANTASTIX INC.

For all your plastics needs...

Greeting Card Rack – Two Tier.....	16
Greeting Card Rack – Three Tier.....	16
Greeting Card Rack – Four Tier	17
SHELVING.....	18
60° Angled Slatwall Shelf.....	18
Slatwall Tilt Back Shelves.....	18
Slatwall Shelves.....	19
Slatwall Shelf – Flat.....	19
Slatwall Single and Double Hosiery Bins.....	19
SIGN HOLDERS.....	20
Slatwall Sign Holder.....	20
Sign Holder – T-Style.....	20
Sign holder – Freestanding.....	21
Menu Holder.....	21
DISPLAY CASES	22
Jewellery Display Case - Countertop.....	22
Cubed Wall Display.....	22
Large Lockable Showcase.....	23
Multi-Shelf Security Cabinet.....	23
MISCELANEOUS.....	24
Podium.....	24
Lollipop Display – 4 Tier.....	24



PLASTIX FANTASTIX INC.

For all your plastics needs...

About Us

Plastix Fantastix Inc. was started in 1998 by Dave Magee. With over twenty five years of experience in distribution and fabrication industries and a commitment to customer service, our company is dedicated to serving your needs. Our services include:

- Brochure Holders
- Picture Frames
- P.O.P. Displays
- Slatwall Shelves & Accessories
- Food and Candy Bins
- C.N.C. Routing
- Vacuum Forming
- Custom Acrylic & Sign Fabrication

Materials

We are also a distributor of plastics available in sheet, rods, tubes, profiles.

- | | |
|-------------------------|------------------------|
| • ABS | • Nylons |
| • Acetal | • PE Films |
| • Acrylics | • PETG |
| • Butyrate | • Phenolic |
| • C.A.B. | • Plexiglass® |
| • Clear Flex Door Strip | • Polycarbonate Lexan® |
| • Coroplast® | • PVC |
| • Cutting Board | • Polyurethane |
| • Delrin® | • P/P |
| • Flexible Tube | • Styrene |
| • Foam Boards | • Sintra® |
| • HDPE | • Teflon® |
| • Lay Flat Tubing | • UHMW-PE |
| • Mirror | • Ultraboard |
| • Nalgene Tanks | • Welding Rods |



PLASTIX FANTASTIX INC.

For all your plastics needs...

1. DISPLAY RISERS

1. Round Display Risers – 3 Tier

Materials: 3/16" Clear Acrylic

Size	Part Number
3"H x 6"D, 8"H x 8"D, 13"H x 10" d	PF144



Round Display Risers – 4 Tier Square Base

Base: 3/8"

Materials: 1/4" Clear Acrylic & Clear Rod

Size	Part Number
3"H, 8"H, 13"H, 18"H, 23"H	PF145

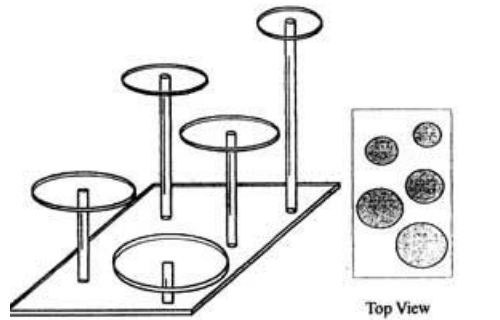

Round Display Risers – 4 Tier Curved Base

Materials: 1/4" Clear Acrylic & Clear Rod

Base: 3/4" Plexiglass

Size	Part Number
3"Hx6"D, 5"H x 8"D, 8"H x 10"D, 13"H x 12"D	PF146

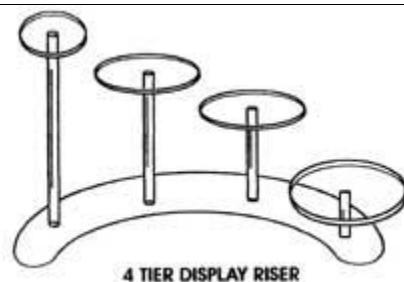



PLASTIX FANTASTIX INC.

For all your plastics needs...

Round Display Risers – 5 Tier

Materials: 1/8" Clear Acrylic & Clear Rod

Optional: 1/8" Mirror base Optional – Size 16"W x 9" d

Size	Part Number
3", 5", 7"High	PF152

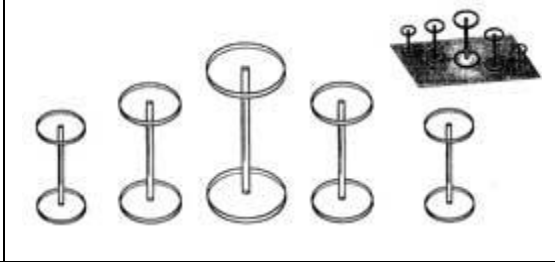

2. Tube Display

Custom sizes available.

Size	Part Number
8" High with 16" base	PF149

Diameter of the tube may vary.

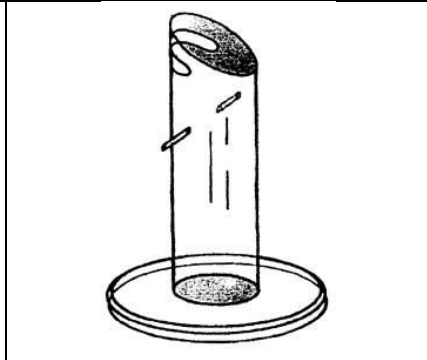

3. Step Riser – 3 Tier

Available in clear, mirror & black. Comes with removable legs

Size	Part Number
6" Wide	PF147
12" Wide	PF148

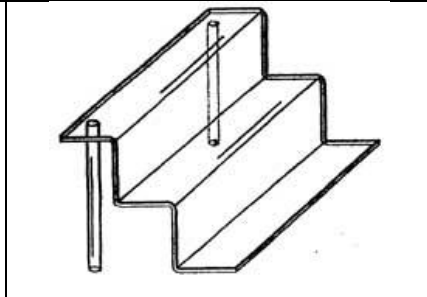



PLASTIX FANTASTIX INC.

For all your plastics needs...

Step Riser – 4 Tier

Materials: 1/8” Clear Acrylic

Optional: Mirror backing

Size	Part Number
12 1/2” w x 17” h x 12”D	PF138

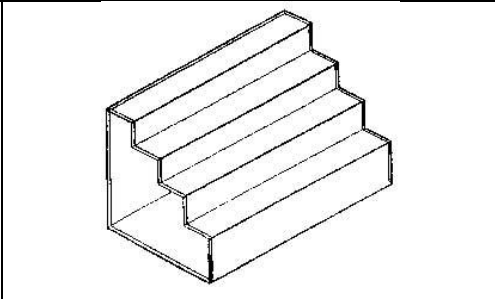

Cube Riser/Cover

Five sided cubes.

Size	Part Number
6” x 6” x 6” (4.5mm)	PF093
8” x 8” x 8” (4.5mm)	PF094
10” x 10” x 10” (4.5mm)	PF095
12” x 12” x 12” (4.5mm)	PF096
15” x 15” x 15” (6mm)	PF097
18” x 18” x 18” (6mm)	PF098

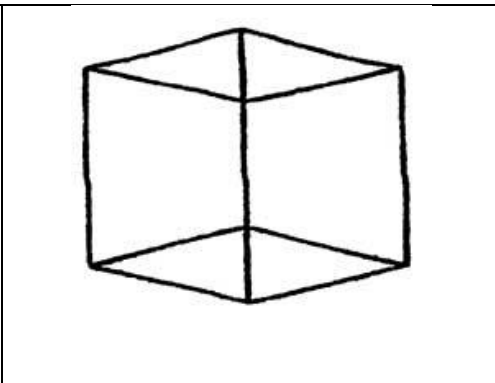

Rectangular Risers

Three sided, U shaped.

Size (L x W x H)	Part Number
3” x 3” x 3” (2.5mm)	PF099
4” x 4” x 4” (2.5mm)	PF100
5” x 5” x 4” (2.5mm)	PF101
6” x 6” x 6” (2.5mm)	PF102
8” x 6” x 6” (2.5mm)	PF103
10” x 6” x 8” (2.5mm)	PF104
6” x 6” x 6” (4.5mm)	PF105
8” x 8” x 8” (4.5mm)	PF106
10” x 10” x 10” (4.5mm)	PF107
12” x 12” x 12” (4.5mm)	PF108

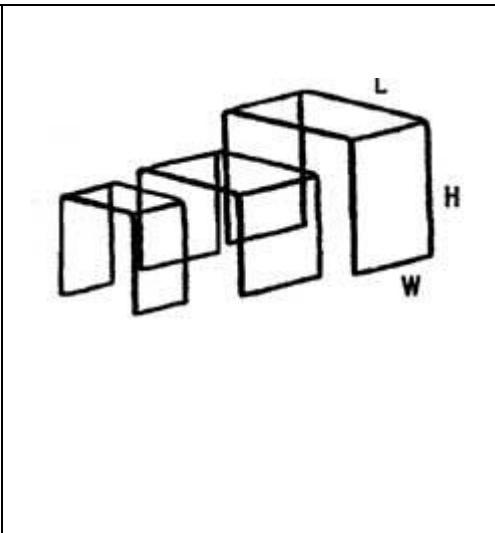



PLASTIX FANTASTIX INC.

For all your plastics needs...

JEWELLERY DISPLAYS

Jewellery Card Slatwall Display

4.5mm thickness.

Size	Product Number
8"W x 9" h (4 tiers)	PF085
8" w x 18"H (7 tiers)	PF086
15 1/2"W x 18"H (7 tiers)	PF087

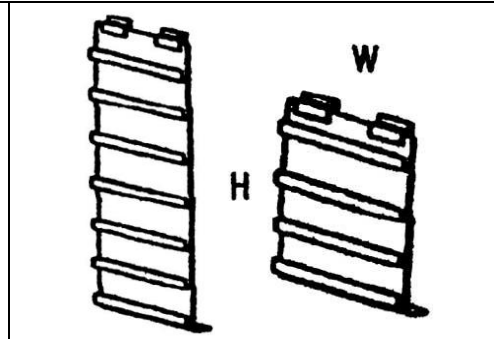

4. Triangular Slatwall Mount Jewellery Display

2.5mm thickness

Size	Product Number
8 1/2"W x 14 1/2"H x 7 1/2" D	PF091
Bracelet holder 8"W x 8"H	PF092

Optional bracelet attachment available for top.
Adaptable to slatwall or wall mount.

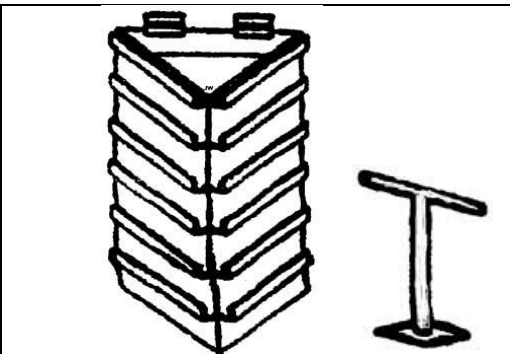

5. Jewellery Card Display – Free standing

4.5mm thickness

Size	Part Number
8"W x 18"H (7 tier)	PF088

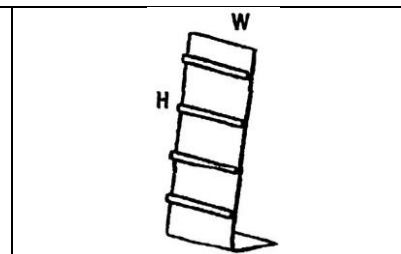



PLASTIX FANTASTIX INC.

For all your plastics needs...

6. Bracelet Display – Single Arm

Available in different sizes.

Size	Part Number
4"W x 7"D (base) x 10" h	PF150

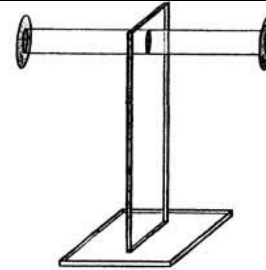

7. Bracelet Display – Two Arm

Available in different sizes.

Size	Part Number
4"W x 7"H x 10"H	PF151

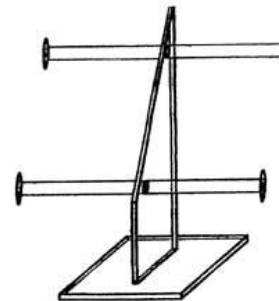

8. Eyeglass Display

2.5mm thickness

Size	Part Number
4"W x 24"H (Slat or Wall Mount)	PF089
4"W x 24"H (Angled, Counter-top)	PF090

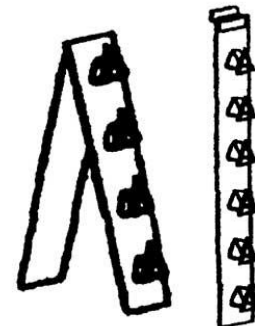



PLASTIX FANTASTIX INC.

For all your plastics needs...

2. BUSINESS CARD & BROCHURE HOLDERS

1. Business Card Holders - Single

2.5mm thickness.

Size	Part Number
3 1/2"W x 2" h	PF013
3 1/2"W x 2" h	PF014

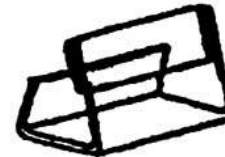
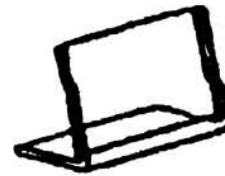

PF013

PF014

2. Business Card Holder – Multiple – Screw /Slat Wall Mount

2.5 mm thickness. Also available in Slat mount

Material: 3/16" Clear Arcylic

Size	Part Number
13"W x 17" h	PF142

*Custom sizes also available

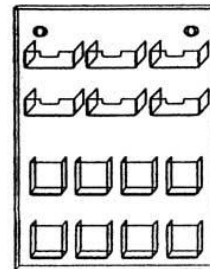



PLASTIX FANTASTIX INC.

For all your plastics needs...

3. Business Card and Brochure Holder

Available in slatwall or screw mount. Custom sizes available. Removable divider.

Material: 3/16" Clear Arcylic

Size	Part Number
9 1/2"W x 2 1/2"D	PF141

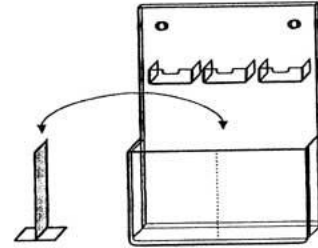

4. Business Card Holder – Multiple - Freestanding

2.5mm thickness.

Size	Part Number
11"W x 12" h	PF015

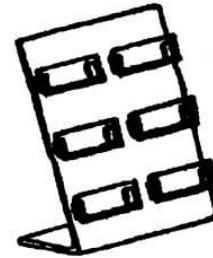

5. Brochure Holder - Single

Size		Part Number
5"W x 9"H	Wall Mount	PF020
8 1/2"W x 11"H	Wall Mount	PF021
5"W x 9"H	Slatwall	PF018
8 1/2"W x 11"H	Slatwall	PF019
5"W x 9"H	Desk Mount	PF016
8 1/2"W x 11"H	Desk Mount	PF017

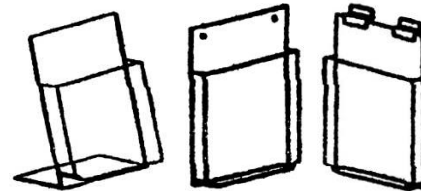



PLASTIX FANTASTIX INC.

For all your plastics needs...

6. Brochure Holder – Free Standing

Materials: 1/8" clear styrene

Size	Part Number
8 1/2"W x 11"H	PF110
6 1/4"W x 9" h	PF111
4 1/4"W x 9" h	PF112
(Business card holder)	PF113

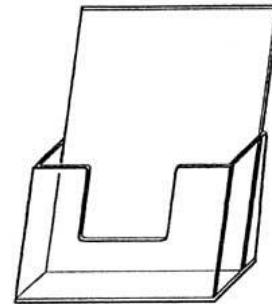

7. Brochure Holder – Multiple – Wall Mount

Available in wall mount or for slatwall.

Materials: 1/8" Clear Arcylic

Size	Part Number
8 1/2"W x 14" h	PF140

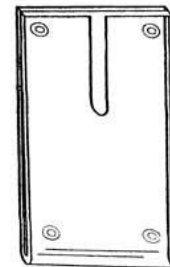

8. Brochure Holder – Multiple Tier

3/16" thickness.

Size	Part Number
9 1/4"W x 18 1/2"L x 15 1/4"H (4 tier)	PF025
7 3/4"W x 18 1/2"L x 12 1/4"H (3 tier)	PF026
6 1/4"W x 19 1/2"L x 9 1/4"H (2 tier)	PF027
6"W x 12"H x 18"D	PF006

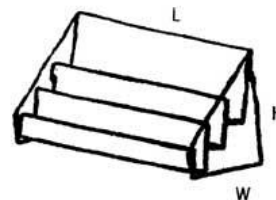



PLASTIX FANTASTIX INC.

For all your plastics needs...

9. Counter Pocket

Size	Part Number
4"W x 9" h	PF022
9"W x 11"H	PF023
8 1/2" x 11"H	PF024

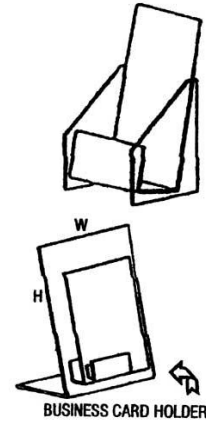

10. Magazine Holder – Wall mount

Available in slatwall or screw mount. Custom sizes available.

Material: 3/16" Clear Arcylic

Size	Part Number
9 1/2"W x 11"H x 2 1/2"D	PF109

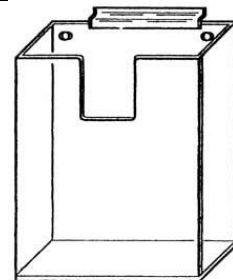



PLASTIX FANTASTIX INC.

For all your plastics needs...

3. BULK BINS

1. Bulk Food Bin

Comes with hinged lids. Available in slatwall mount. Custom sizes available.

Materials: 3/16" Clear Arcylic

Size	Part Number
?”W x ?”H x ?d Large	PF153
?w x ?h x ?d Medium	PF154
?w x ?h x ?d Small	PF155

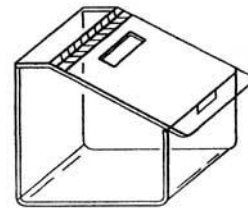

2. Bulk Food Bin – Optional Scoop Holders

Scoop holders and sign holders are available upon request.

Size	Part Number
6”W x 12”H x 18”D (Sign & Scoop holder incl.)	PF001
6”W x 12”H x 18”D	PF002
12”W x 12”H x 12”D (Sign & Scoop holder incl.)	PF003
12”W x 12”H x 12”D	PF004
6.”W x 12”H x 18”D (Sign & Scoop holder incl.)	PF005
6”W x 12”H x 18”D	PF006

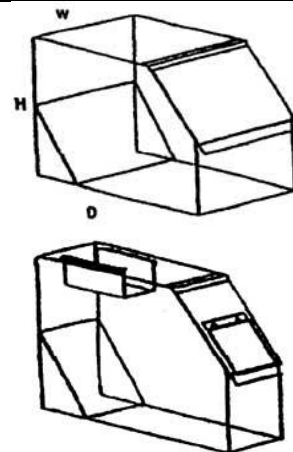



PLASTIX FANTASTIX INC.

For all your plastics needs...

4. DRAW & DONATION BOXES

1. Draw Box

2.5mm thickness.

Comes complete with hinge, split and lock.

Size	Part Number
12" x 12" x 12"	PF007
12" x 12" x 12"	PF008

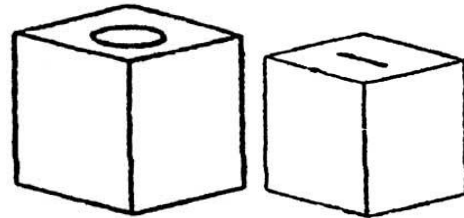

2. Donation Box

2.5mm thickness. Canister and box with sign holder models. Printing available.

Size	Part Number
3"D x 6"H	PF009
23"D x 3"H w 7" sign holder	PF010

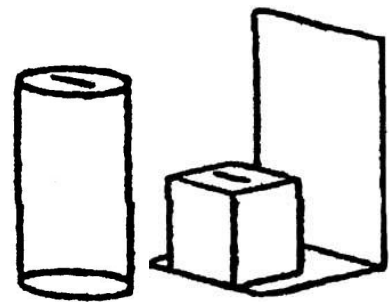



PLASTIX FANTASTIX INC.

For all your plastics needs...

5. GREETING CARD HOLDERS

1. Greeting Card Rack - Single

Acrylic. Available in Counter, Wall mount and slotwall.

Size	Part Number
16" wide	PF122
24" wide	PF123
36" wide	PF124
48" wide	PF125

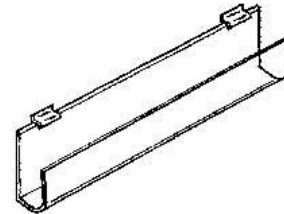

Greeting Card Rack – Two Tier

Acrylic. Available in Counter, Wall mount, and slotwall.

Size	Part Number
16" wide	PF126
24" wide	PF127
36" wide	PF128
48" wide	PF129

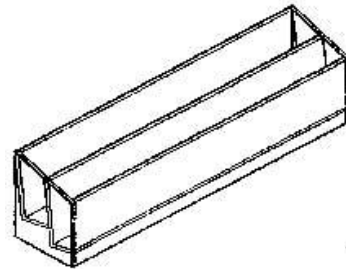

Greeting Card Rack – Three Tier

Acrylic. Available in Counter, Wall mount, and slotwall.

Size	Part Number
16" wide	PF130
24" wide	PF131
36" wide	PF132
48" wide	PF133

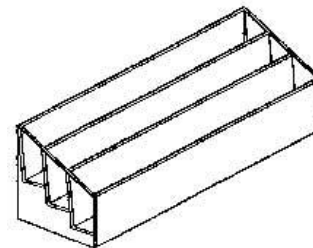



PLASTIX FANTASTIX INC.

For all your plastics needs...

Greeting Card Rack – Four Tier

Acrylic. Available in Counter, Wall mount, and slotwall.

Size	Part Number
16" wide	PF134
24" wide	PF135
36" wide	PF136
48" wide	PF137

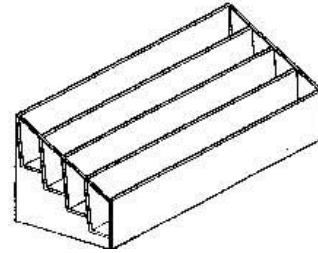



PLASTIX FANTASTIX INC.

For all your plastics needs...

6. SHELVING

1. 60° Angled Slatwall Shelf

4.5mm thickness.

Size	Part Number
12"W x 12"L	PF028
12"W x 21"L	PF029
12"W x 36"L	PF030
12"W x 48"L	PF031

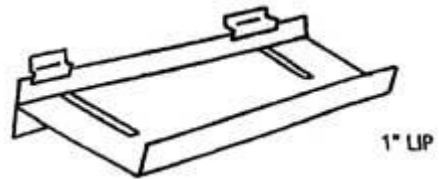

2. Slatwall Tilt Back Shelves

2.5mm thickness

Size	Part Number
18"L Open Ends	PF065
18"L Closed Ends	PF066
23 3/4"L Open Ends	PF067
23 3/4"L Closed Ends	PF068
30"L Open Ends	PF069
30"L Closed Ends	FP070
36"L Open Ends	PF071
36"L Closed Ends	PF072

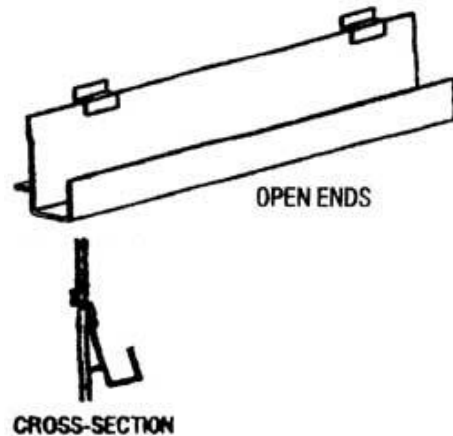



PLASTIX FANTASTIX INC.

For all your plastics needs...

Slatwall Shelves

4.5mm thickness

Size	Part Number
12''W x 22''L 15 ° Angle	PF075
12''W x 22''L Straight	PF076
12''W x 46''L 15 ° Angle	PF077
12''W x 46''L Straight	PF078
12''W x 35''L 15° Angle	PF079
12''W x 35''L Straight	PF080
12''W x 12''L	PF081

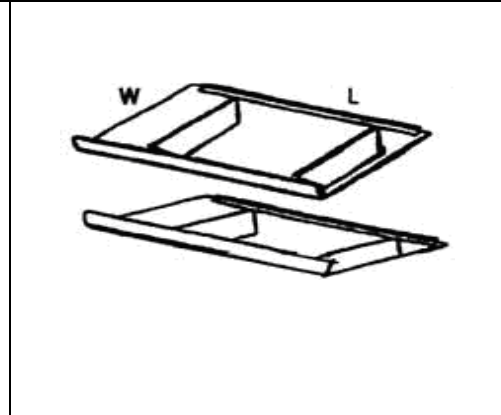

3. Slatwall Shelf – Flat

2.5mm thickness

Size	Part Number
4''W x 10''L	PF082
12''W x 12''L	PF083
4''W x 10''L (with 1'' Lip)	PF084

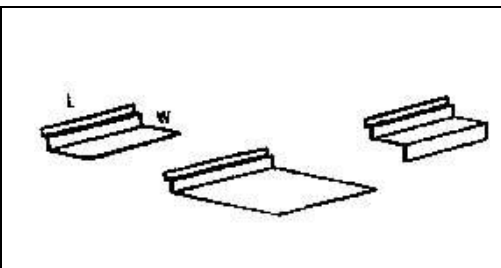

Slatwall Single and Double Hosiery Bins

2.5mm thickness. Holds 7'' wide packaged hose, 4 1/2'' deep with 4 1/2'' front lip.

Size	Part Number
Single Bin	PF011
Double Bin	PF012

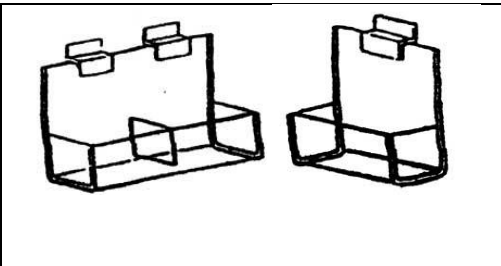



PLASTIX FANTASTIX INC.

For all your plastics needs...

7. SIGN HOLDERS

1. Slatwall Sign Holder

2.5mm thickness

Size	Part Number
3 1/2"W x 5 1/2"H	PF055
5 1/2"W x 3 1/2"H	PF056
5 1/2"W x 7"H	PF057
7"W x 5 1/2"H	PF058
11"W x 7"H	PF060
8 1/2"W x 11"H	PF061
11"W x 8 1/2"H	PF062
11"W x 14"H	PF063
14"W x 11"H	PF064

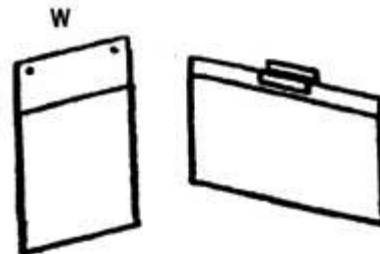

ADAPTABLE TO SLATWALL GRID OR WALLMOUNT

Adaptable to slotwall grid or wall mount

2. Sign Holder – T-Style

Materials: 1/8" Clear Arcylic

Size	Part Number
4"W x 6"H	PF114
5"W x 7"H	PF115
8 1/2"W x 11"W	PF116
11"W x 8 1/2"H	PF717
7"W x 11"H	PF046
11"W x 7"H	PF047
11"W x 14"H	PF048
14"W x 11"H	PF049

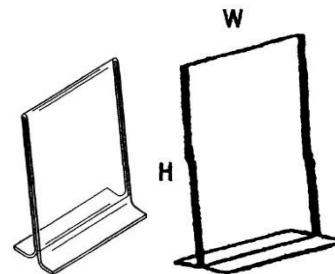



PLASTIX FANTASTIX INC.

For all your plastics needs...

Sign holder – Freestanding

2.5mm thickness

Size	Part Number
3 ½"W x 5"H	PF036
8 ½"W x 11"H	PF037
5"W x 7"H	PF038
7"W x 5"H	PF039
7"W x 11"H	PF040
11"W x 7"H	PF041
4"W x 6"H	PF118
11"W x 8 ½"H	PF121

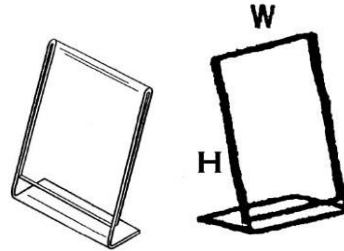

3. Menu Holder

2.5mm thickness

Size	Part Number
4"W x 7"L L Shape	PF034
4"W x 7"L T Shape	PF035

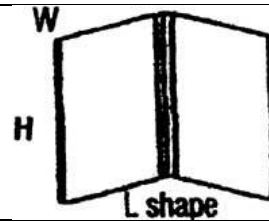



PLASTIX FANTASTIX INC.

For all your plastics needs...

8. DISPLAY CASES

1. Jewellery Display Case - Countertop

Unit comes with three adjustable bars for necklaces and bracelets.

Material: 3/16" Clear Acrylic

Size	Part Number
11 1/4"W x 24"H x 7 1/2"D	PF156

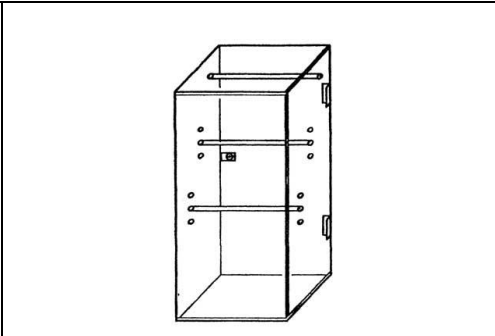

2. Cubed Wall Display

Available in slatwall or screw mounted.

Materials: 3/16" Clear Acrylic

Size	Part Number
12"W x 12"H x 10"D	PF139

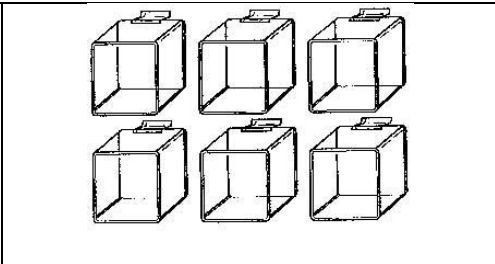



PLASTIX FANTASTIX INC.

For all your plastics needs...

3. Large Lockable Showcase

Comes with size compartments. Casters optional.

Materials: 1/4" Clear Acrylic

Size	Part Number
14"W x 14"D x 48"H	PF158

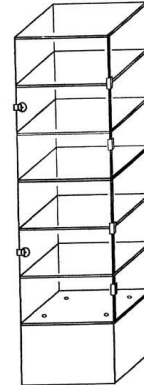

4. Multi-Shelf Security Cabinet

4.5mm thickness. Showcase with four flat shelves and pivot. Hinged front panel with security lock. Can be adapted for slatwall. Specify on order.

Size	Part Number
11 1/2"W x 23"L x 7 1/2"D Single door	PF032
11 1/2"W x 23"L x 7 1/2"D Double door	PF033

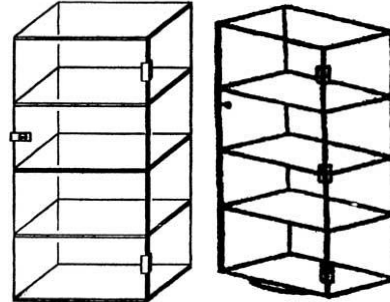



PLASTIX FANTASTIX INC.

For all your plastics needs...

9. MISCELANEOUS

1. Podium

Available in custom sizes.

Materials: 3/8" Clear Acrylic
1/2" Clear Acrylic top

Size	Part Number
48"H x 30"W x 16"D	PF159

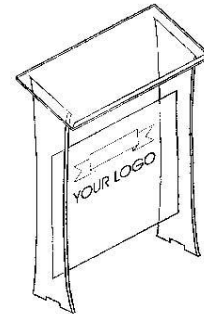

2. Lollipop Display – 4 Tier

Custom sizes available.

Material: 1/2" Clear Acrylic

Size	Part Number
17 1/2"W x 8"H x 3 1/2"D	PF143



Top View

